

BELTS MADE  
OF WOVEN MESH  
AND SPIRALS



# PROCESS BELTS FOR THE WOOD INDUSTRY

FLEXOPLAN™ | CONDUCTO® | SQUARE WEAVE | TELA MICRODUR | LINEAR SCREEN



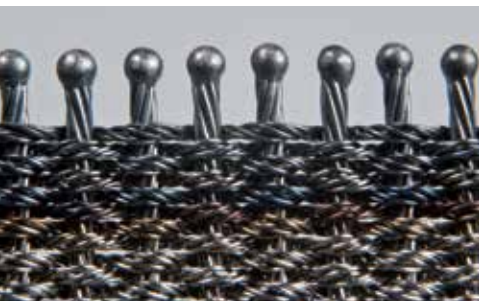

1. OSB for the construction industry 2. FLEXOPLAN 163 Special with welded edges 3. Connection guides: riveted, soldered or made of sheet metal

## FLEXOPLAN™ CAUL SCREENS FOR OSB BOARDS WITH GRIP

Highly robust yet flexible: GKD manufactures custom-built FLEXOPLAN 163 Special solutions for its customers as caul screens for producing OSB boards in stationary single and multi-stage presses. The precise marking of our double-twisted screens ensures that the defined surface coarseness is attained. With a riveted or soldered guide or a special sheet metal guide, FLEXOPLAN caul screens excel in all conventional production facilities. These guides are always manufactured in accordance with the plant constructor's requirements. The consistent high quality and reproducibility of the surface is one of the reasons behind the success of FLEXOPLAN caul screens – and not only in North America's construction industry.

FLEXOPLAN 163 Special (caul screens)	
Number	18.35/4.48 p.cm
Warp	0.19/5x + E
Weft	0.30/7x
Material combination	
carbon steel, complete	Article No.:
	42103010
Special version in SST available	
Weave type	plain weave

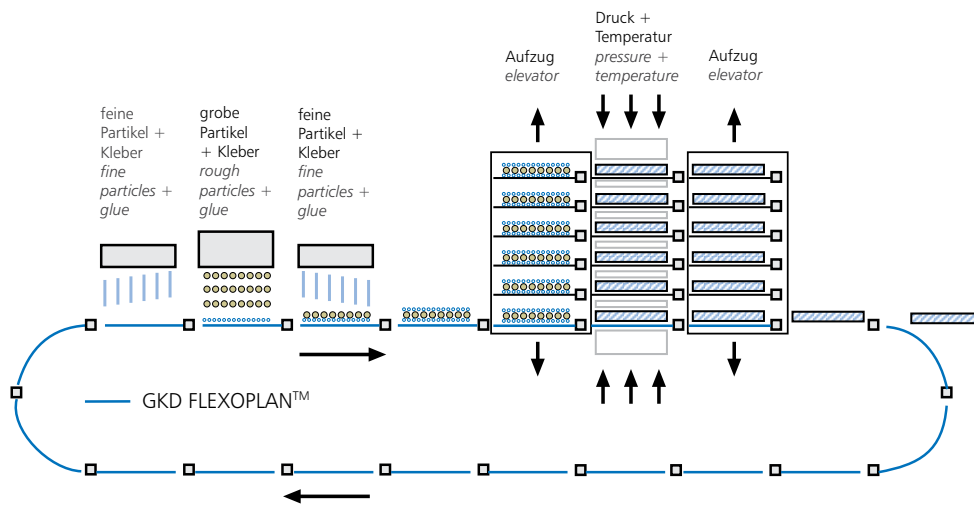

1. Multi-stage press 2. Particle board 3. FLEXOPLAN Type 452 KP

## FLEXOPLAN™ CAUL SCREENS FOR PARTICLE, MDF & FINE SURFACES

When used as a caul screen, FLEXOPLAN Type 452 KP is a proven solution for manufacturing chip or MDF boards with smooth surfaces. Moreover, this mesh type made of fine warp wires and flexible weft wires retains its high degree of flexibility even when pressing at high temperatures.

The efficiency and process safety of our FLEXOPLAN Type 452 KP caul screens with twilled weave mesh make them the perfect solution for presses of these and other renowned manufacturers: Becker & van Hüllen, Bison, Dieffenbacher, Metso, Motalla, Rautte, Schenck, Siempelkamp, Sunds and Washington Iron.

### FLEXOPLAN 452 KP (caul screens)

Number	78.76/5.95 p.cm
Warp	0.25 mm
Weft	0.30/7x

Material combination	Article No.:
carbon steel, complete	14164000
SST/carbon steel	14343410
SST, complete	14343411
Weave type	twilled weave 2/2



— GKD Press-Prägeband / Embossing press belt

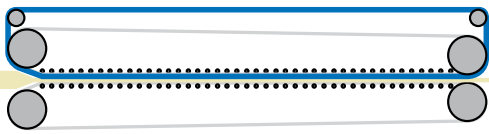

1. Embossed OSB board 2. Diagram of a continuous press 3. Embossing press belt on GKD stretching bench

## FLEXOPLAN™ EMBOSSING PRESS BELTS FOR CONTINUOUS OSB MANUFACTURING

FLEXOPLAN 163 Special embossing press belts distribute steam in the press quickly and evenly. This is made possible by a stainless steel mesh construction made of pre-twisted metal cables. The belts allow plates with a final thickness of up to 15 cm to be manufactured, as required for instance for producing OSB beams for extending walls and ceilings.

Break-proof up to 200 N/mm, suitable for temperatures up to 250°C, pressure-resistant and accurate even at great lengths – these properties also make the mesh ideal for continuous presses. The FLEXOPLAN 163 Special is available as an endless process belt with a width of up to five metres and a length of 200 metres.

### FLEXOPLAN™ 163 Special (embossing press belts)

Number 18.35/4.48 p.cm

Warp 0.19/5x + E

Weft 0.30/7x

Material combination

Article no.:

SST, complete

42370304

Version with soldered seam and welded loop pin seam

Weave type plain weave

— GKD CONDUCTO® Entlüfterband / ventilation belt

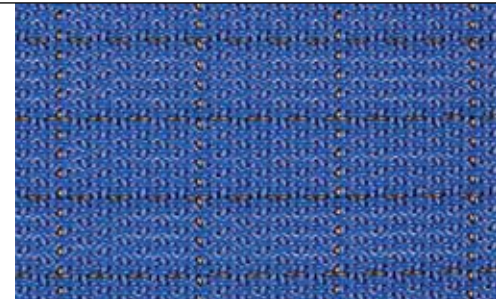
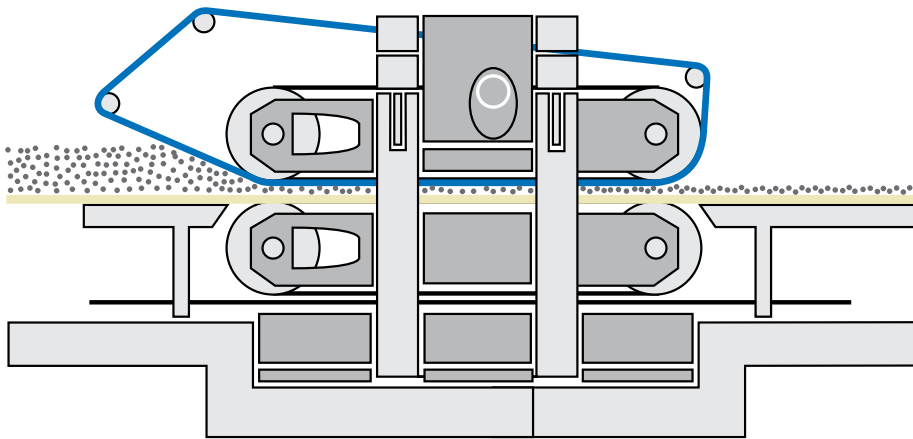

1. Diagram of prepress 2. CONDUCTO 2206 3. CONDUCTO 5090

## CONDUCTO® VENTILATION BELTS FOR ATEX-COMPLIANT APPLICATIONS

CONDUCTO is a patented ventilation belt that sets new standards for safety and productivity in the prepress. The polyester and bronze wire process belt combines high flexibility, robustness, air permeability and surface smoothness with maximum conductivity. Bronze wires woven either in warp direction or in grid form permanently prevent electrostatic charging as per the ATEX standard. As such, CONDUCTO ventilation belts reduce the risk of fire and explosion when manufacturing chip boards. Furthermore they also prevent damage to the board surfaces caused by adhesion of particles. The conductive blended mesh belts are available in widths of up to 3.4 metres. They are designed specifically to match your processes with woven pin seam, woven seam, GKD PAD seam or S-seam and can be mounted quickly on site.

CONDUCTO	Type 2206	Type 5090
Material warp	PES/bronze	PES/bronze
Material weft	PES/bronze	PES
Weave	2/2	3/2
Tensile strength N/mm	210	250
Opening $\mu\text{m}$	550	360
Air permeability $\text{l/m}^2\text{s}$ 200 Pa	2750	2200
cfm 127 Pa	425	340

ATEX 95  

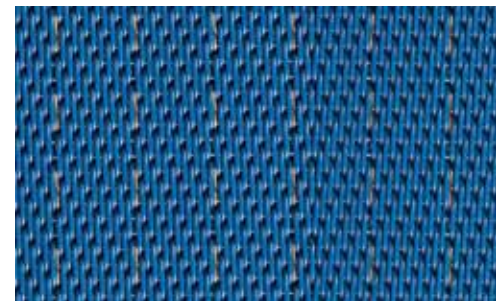

1. CONDUCTO process belts for drying wood shavings 2. PAD seam 3. CONDUCTO 5065

## CONDUCTO®-PROCESS BELTS FOR PERFECTLY DRIED BIOMASS

The patented CONDUCTO 5065 is a process belt that enables optimised drying of wood shavings or other biomasses in low-temperature dryers. The high degree of air permeability and small mesh opening guarantee an effective drying process, while the special mesh construction provides reliable protection from dust. When deployed in an efficiently planned system, this helps our customers comply with the legally stipulated dust load values. The special mesh construction not only achieves excellent dust load values and air permeability, but also a

robust belt with a particularly high level of lateral stability and tensile strength. Moreover, the CONDUCTO 5065 is precise and resistant to abrasion. During production, the mesh is subjected to a special thermal treatment, allowing it to be used at working temperatures of up to 130°C. Bronze wires interwoven in the running direction permanently prevent electrostatic charging as per the ATEX standard. The belts can be cleaned easily and thoroughly using brushes or high-pressure belt washing systems. Thanks to its versatile properties, this

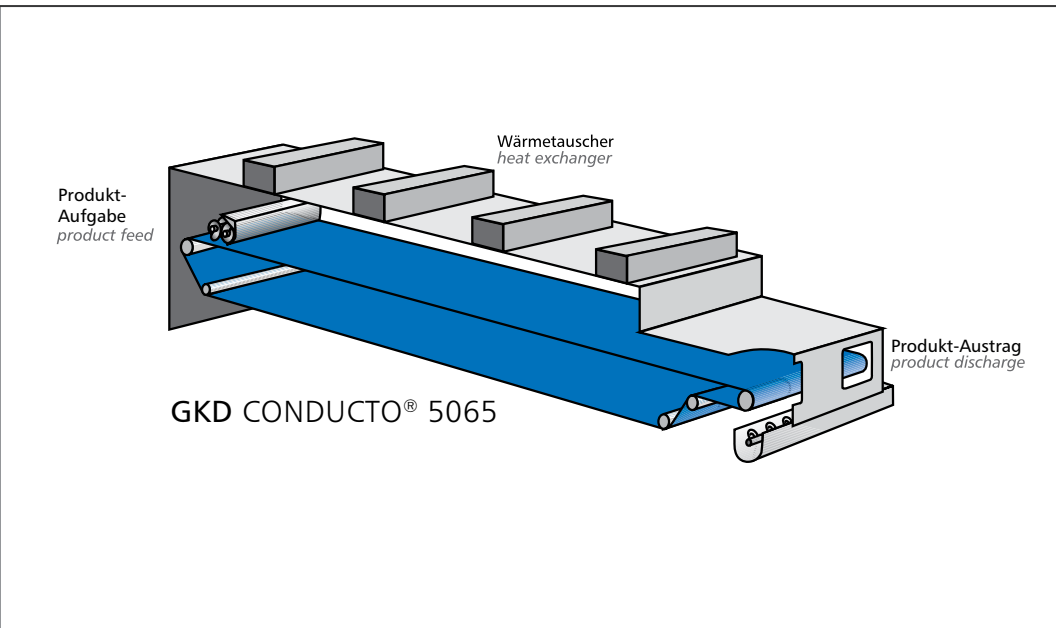

1. Diagram of belt dryer 2. Tow in device 3. Pellets

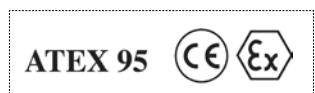

process belt has become well established on the market. Today it is used in all conventional low-temperature dryers and is exclusively fitted by numerous renowned machine manufacturers worldwide. Our robust CONDUCTO 5065 process belt is available in widths of up to 8.2 metres and lengths of up to 200 metres. To ensure the smooth installation of the belts, we can also provide you with a mounting kit for fixing the seam area and a tow in device to help feed the belt into the system on request.

CONDUCTO	Type 5065
Material warp	PES/bronze
Material weft	PES
Weave	3/2
Tensile strength N/mm	300
Opening $\mu\text{m}$	540
Air permeability $\text{l/m}^2\text{s 200 Pa}$	3600
cfm 127 Pa	550
Tensile strength/breaking force PAD seam 20	150 N/mm

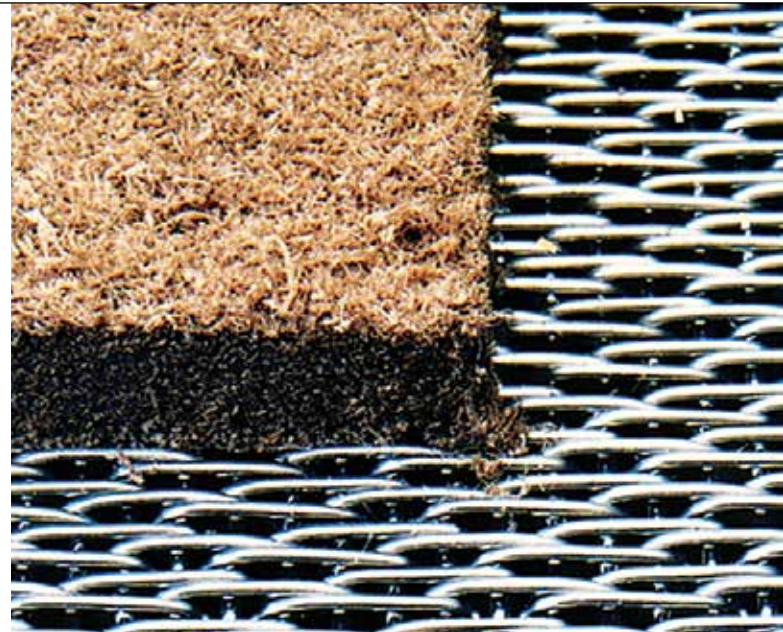
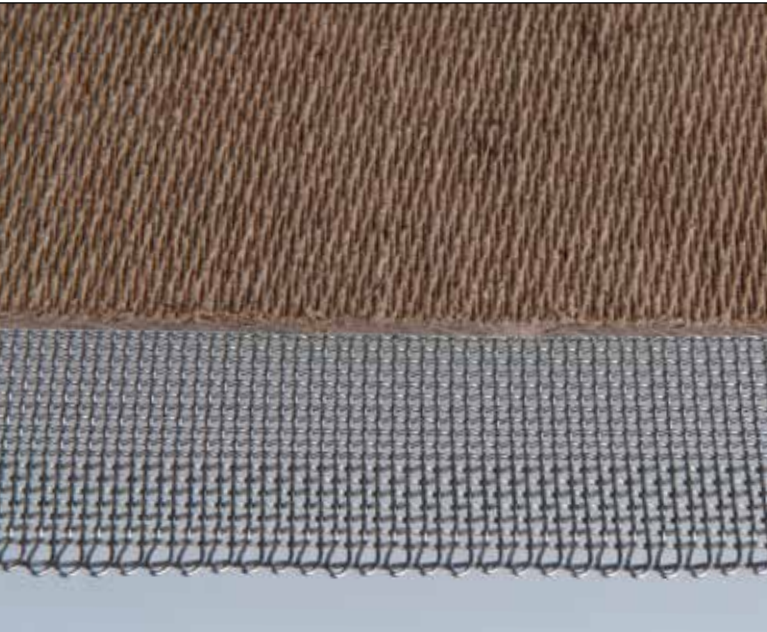

1. Press mesh with selvedge 2. TELA MICRODUR

## SQUARE WEAVE + TELA MICRODUR FOR FB HARD PARTICLE BOARDS

Our stainless steel SQUARE WEAVE and TELA MICRODUR meshes have been tried and tested as reliable press draining meshes for many years, and are today used in the furniture and automotive industries among other areas. These solutions allow manufacturers all over the world to produce FB hard particle boards economically and effectively using a wet process. Our SQUARE WEAVE stands out in particular thanks to its plain weave and stable woven edge. This mesh is an ideal choice for manufacturing FB hard particle boards with its characteristic surface structure. The special weave of

the TELA MICRODUR mesh is the perfect solution when the end product needs to have a particularly smooth surface. These smooth surfaces guarantee a good product discharge and are highly cost-effective in production. Both meshes stand out thanks to their outstanding dewatering performance. They are produced solely in our competence centre for press draining meshes in South Africa. Like all process meshes from GKD, they are manufactured according to the individual specifications and applications of our customers.



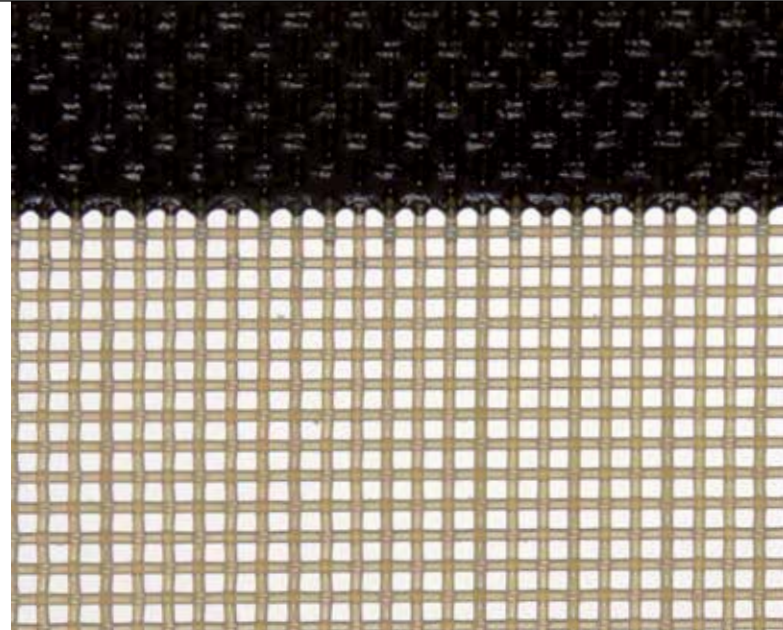
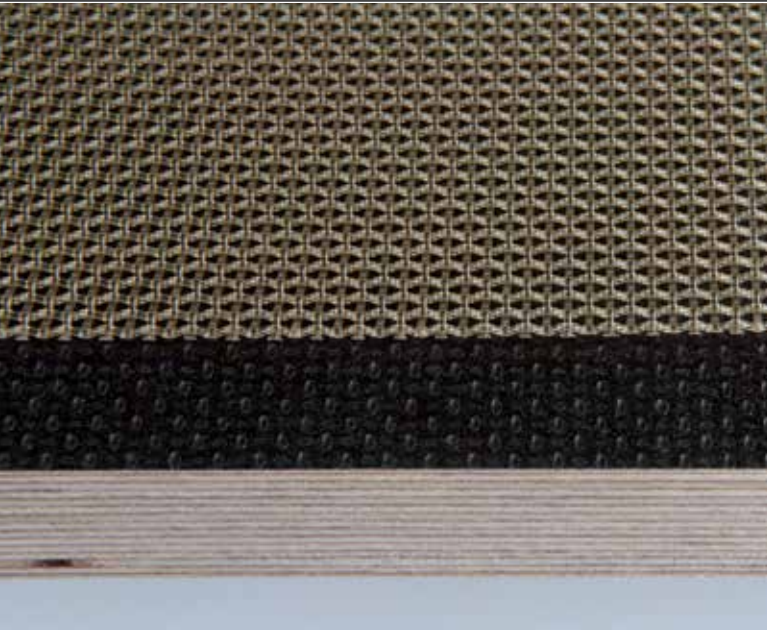

1. Multiplex board with GKD LINEAR SCREEN 1300 2. PPS with special GKD edge coating

## LINEAR SCREEN FOR PRESSING VENEERS

LINEAR SCREEN 1300 and 3000 made from polyphenylene sulphide (PPS) are reliable meshes for pressing veneers when manufacturing multiplex (textured coated) boards. Among other applications, these boards are often used as non-slip flooring in industrial plants or truck and trailer manufacturing. Our mesh lends the board its distinctive structure. To realise this non-slip surface, high temperatures and pressing power are required during the production process. This is where conventional plastics and adhesives

reach their limits. For this reason, LINEAR SCREEN employs an individually extruded plastic consisting of polyphenylene sulphide and a special adhesive for edge coating in the veneer industry. After weaving, the mats also undergo a complex thermal treatment procedure in order to prevent shrinkage during the tough production processes of our customers. In this connection, the edges of all LINEAR SCREEN meshes are also finished with an innovative and highly heat-resistant edge coating.

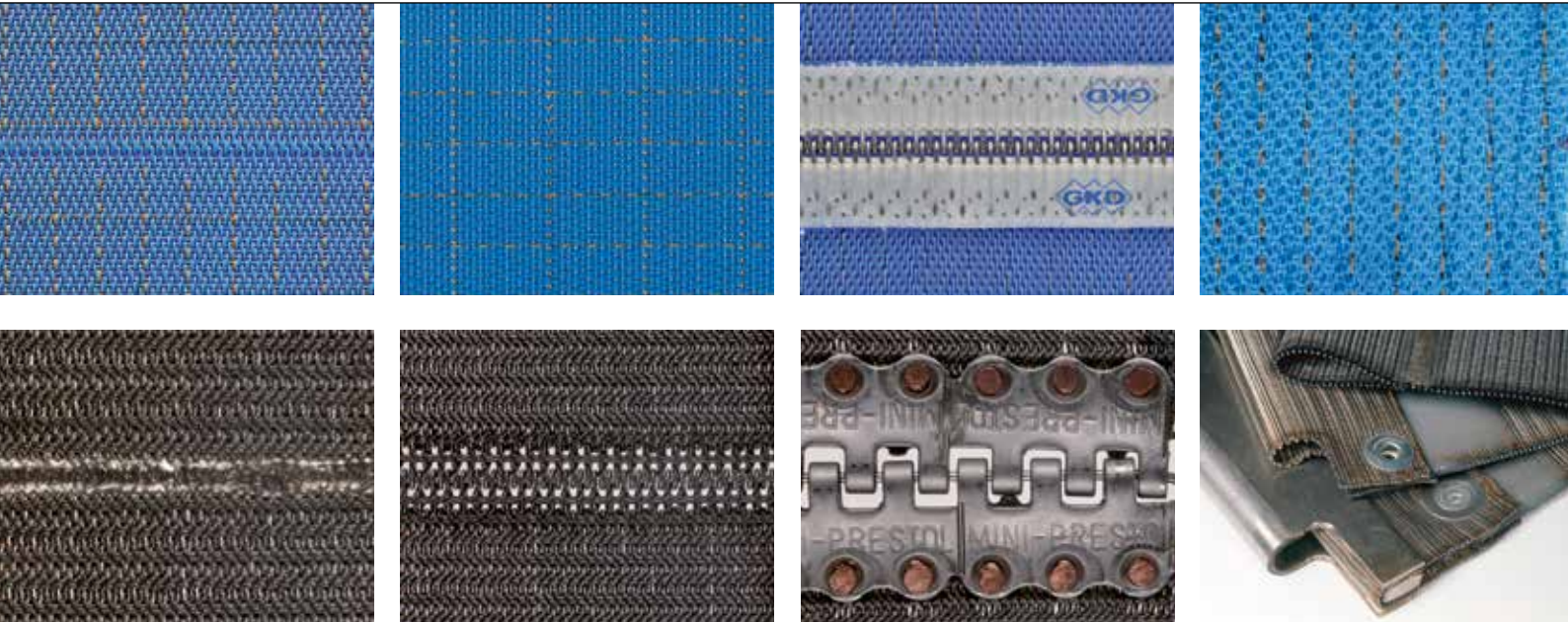

Seam variants for plastic (1-4) and metal (5-8)

## INDIVIDUAL SEAM SOLUTIONS FOR EVERY APPLICATION

Like our meshes themselves, the seams also have to withstand extremely tough conditions: depending on the area of application, we combine one of our seam variants with the optimum mesh for our customers' production processes. We are happy to support and advise you in choosing the right seam for your particular requirements.

The patented and particularly flat PAD seam is exclusively available from GKD. In a hot melting procedure, a special pad is melted into the belt mesh and pressed together with staples. As a result, the special seam is stronger, more durable and possesses better running properties. Furthermore, the risk of damage to the seams is reduced to a minimum, the seam area is closed more tightly and product penetration is reduced.

SEAMS FOR PLASTIC BELTS (pictures 1-4)	
Woven pin seam	minimal marking, air permeable, can be closed by customers
Woven seam	non-marking, continuous air flow
GKD PAD seam	particularly thin, robust and minimal-marking hook seam, patented and exclusive from GKD
S-seam	minimal marking, can be closed on customer's premises using a hot press
SEAMS FOR METAL BELTS (pictures 5-8)	
Soldered seam	available with prepared seam for soldering into the system by GKD fitters or as an endless belt. Both options offer minimal marking and high tensile strength
Welded loop pin seam	enables the belt to be closed by the customer on their own premises
Miniprestol seam	robust seam for Flexoplan mesh belts
Connection guide	customised production in accordance with drawing provided

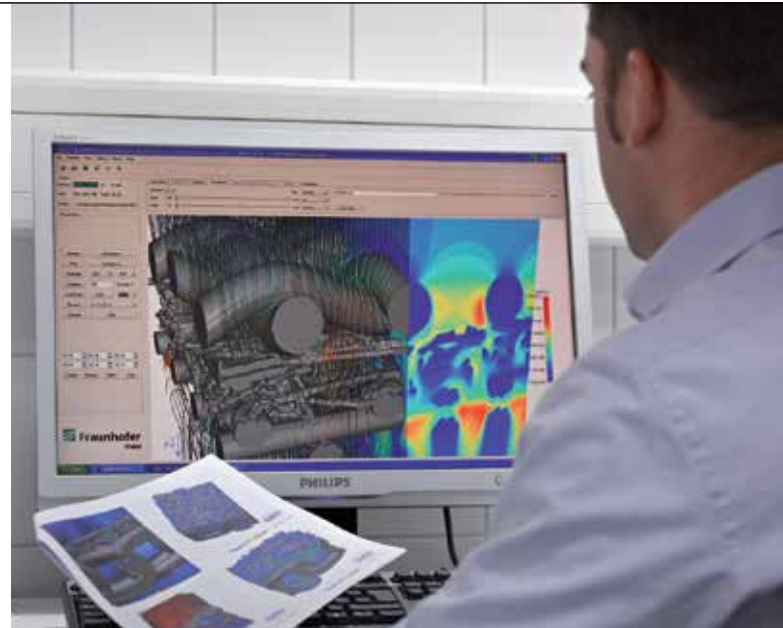

1. Mesh construction 2. Computer simulation

## RESEARCH + DEVELOPMENT FOREVER BETTER PRODUCTS

Technical expertise and optimal customer benefit – this is GKD's mission for all process meshes employed in the wood industry. That's why we focus on the development of new meshes in addition to our existing product portfolio. Detailed analyses of current or planned applications always serve as the basis when developing innovative and efficient solutions. Our engineers and technicians combine a wealth of expertise in production, materials and systems with a wide range of practical knowledge of process technologies. Computer simulations support these processes. This all results in excellent GKD mesh quality that is perfectly matched to market requirements. For many years, we have guaranteed this high standard by continuously developing and deploying the very latest manufacturing processes – just like our products themselves.

---

### BENEFITS FOR OUR CUSTOMERS

- VIRTUAL MESH DEVELOPMENT AND PROCESS OPTIMISATION
  - COMPUTER SIMULATIONS FOR PREDICTING PERMEABILITY AS WELL AS PARTICLE AND DIRT PENETRATION
  - EXTENDED SERVICE LIFE THANKS TO OPTIMISED MANUFACTURING AND PROCESS PARAMETERS
-

**GKD - GEBR. KUFFERATH AG**

Metallweberstraße 46  
52353 Düren  
Germany  
T +49 (0) 2421 803 - 0  
F +49 (0) 2421 803 - 182  
processbelts@gkd.de  
www.gkd.de

**GKD - GEBR. KUFFERATH AG**

As a privately owned technical weaver, GKD-Gebr. Kufferath AG is the world market leader in metal, synthetic and spiral mesh solutions. Four independent business divisions bundle their expertise under one roof: **INDUSTRIAL MESH** (woven metal mesh and filter solutions), **PROCESS BELTS** (belts made of woven mesh and spirals), **METALFABRICS** (façades, safety and interior design made of metal fabrics) and **MEDIAMESH®** (transparent media façades). GKD continuously develops new fields of application through its manufacturing technology and process expertise. We use GKD meshes to create efficient systems, equipment and components that are perfectly integrated into our customers' processes across all industrial sectors. GKD is active on the international stage from its headquarters in Germany, five further production sites in the US, South Africa, China, India and Chile, as well as branches in France, Spain, Dubai and representatives all over the world.

**BUSINESS UNIT: PROCESS BELTS**

As a technological leader, GKD offers a wide range of versatile process belts made of mesh and spirals for demanding applications. Customers all over the world use our product range and custom-made solutions to dewater, press, filter, separate, dry, cool or freeze products. In addition, the process belts are used in applications including wood embossing, heat treatment and in the textile and nonwovens industry. Thanks to production on state-of-the-art heavy-duty looms and spiral machines, our process belt types made of plastic, metal or a combination of materials are highly stable and at the same time flexible. Moreover, the ultra-flat PAD seam developed by GKD engineers demonstrates our innovative capacity. We are a reliable partner for all projects from the outset: from consultation and individual development, all the way through to procurement and assembly.

**CLOSE TO THE MARKET AROUND THE GLOBE.**

- ① GKD GERMANY, Düren (headquarters)
- ② GKD FRANCE, La Roque d'Anthéron, Croisilles
- ③ GKD SPAIN, Barcelona
- ④ GKD USA, Cambridge, MD
- ⑤ GKD LATIN AMERICA, Santiago de Chile
- ⑥ GKD SOUTH AFRICA, Randfontein
- ⑦ GKD INDIA, Jaipur
- ⑧ GKD CHINA, Beijing, Qufu
- ⑨ GKD MIDDLE EAST, Dubai

